

Incorporating functionality and value into
**ONE MULTIFUNCTIONAL
DEVICE**



The new
imageRUNNER 2420L/2422L
is all these and more

It's a **printer.**
It's a **copier.**
It's a **scanner.**

Designed with small offices and corporate workgroups in mind, the imageRUNNER 2420L/2422L combines the functions of various essential office peripherals into one single device.

Providing print speeds of 20/22 pages per minute, you can achieve greater productivity at an exceptional value. Meet the needs of your office today with one essential device: the imageRUNNER 2420L/2422L.



FEATURES

User-friendly + Uncompromising functionality



Duplex Automatic Document Feeder automatically sends the originals placed in the feeder to the platen glass to perform duplexing. This optional accessory reduces manual labor, without the need to scan the originals manually.



Large 5-Line Display makes it easier for you to navigate to what you need at a glance.

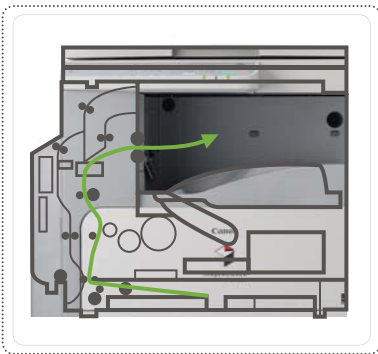

Vertical Paper Path minimizes the likelihood of paper feeding jams. In addition, the shorter paper transport paths also translates to faster image transfer and printing.



Smart Design and Space Saving Internal Finisher adds a professional finish without increasing the device footprint. This optional accessory reduces manual labor with basic stapling and collation features, creating professional-looking documents effortlessly.



Maximum Input Capacity can be increased where needed. Upgrade from the default 250 sheet paper cassette up to a 1,000 sheet capacity to ensure ongoing productivity.

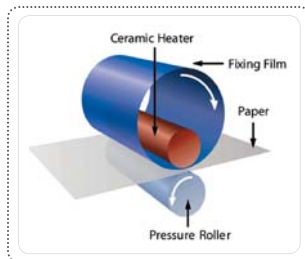

Energy Conservation Design built into Canon's RAPID Fusing System™ means the imageRUNNER device is ready to print instantly when needed, without long warm-up times and energy waste. This increases productivity, reduces energy cost, and helps save the environment at the same time.

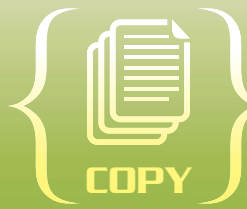

Amazing copy features to get to what you want



Scan-Once-Print-Many

Scan your original document just once, and let the imageRUNNER 2420L/2422L produce copies from the stored digital image, reducing internal device wear and tear.



Scan Once



Digital Image Memory



Multiple Copies

Identification Card Copy

Making copies of ID cards is easy when you use the ID Card Copy function. Both sides of the card will be scanned before they are printed on a single side of the paper.

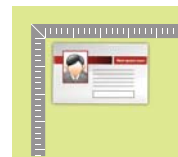

Scan Front of Card



Scan Back of Card



Automatic Single Sheet Copy

Rotation and Collation

imageRUNNER 2420L/2422L allows rotation and collation of paper outputs without requiring optional finishers.

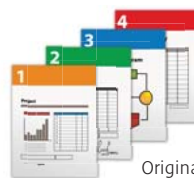

Original



Rotate Collate

Image Combination

Save paper and filing space by combining 4 separate originals onto a single sheet of paper.



Original

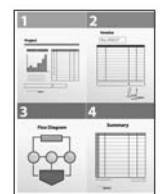
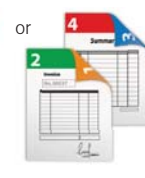

Copy

Enhanced Auto-Magnification

imageRUNNER 2420L/2422L offers a wide zoom ratio range of 25% - 400%. Enlarge or reduce contents to fit your desired paper size automatically at the touch of a button, eliminating the need to guess the copy ratio.



Original



Contents fit to page

Powerful print features are now within reach



Enhanced Digital Local Print

imageRUNNER 2420L/2422L offers you 600 x 600 dpi Standard Local Print, eliminating the costs incurred on an additional standalone printer. Using Canon's innovative Ultra Fast Rendering II (UFR II LT) printing technology, you can achieve an optimal balance of quality and speed for every print job.

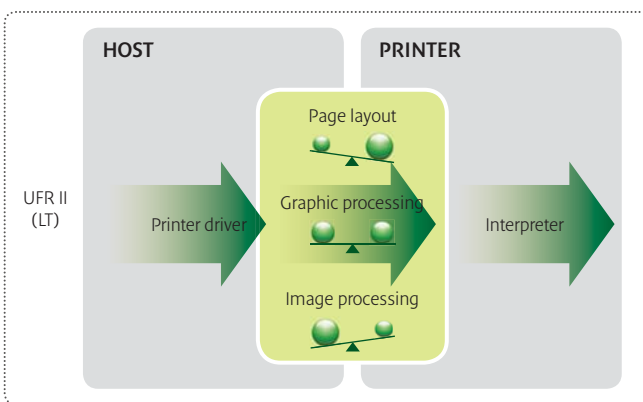

Forced Print with Auto Size Detection

Forced Printing allows paper output when desired output size is out of supply or not available. Letter-sized documents can be force printed to A4, and ledger-sized documents to A3, ensuring critical print outputs.



Convenient Duplex Printing

With an optional integrated duplex unit, you can perform two-sided printing on your imageRUNNER and reduce paper costs significantly.

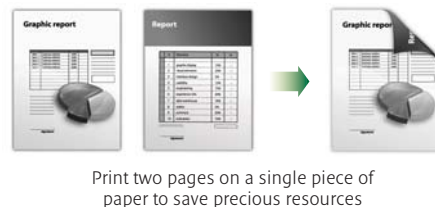

Easier Merging with Page Composer

Canon's Page Composer allows you to merge documents from different applications (Microsoft Word, Excel, PowerPoint, PDF, etc.) into a single electronic document right from your desktop. You can then delete, duplicate and preview the merged document before actual printing.

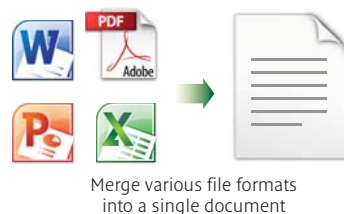

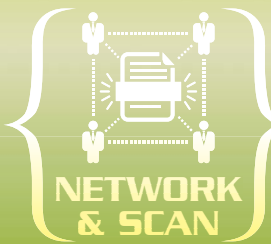

Scan with confidence.
Connect with ease.

Network Printing Capability

The imageRUNNER 2420L/2422L is designed to be an essential part of your office. With the optional network card installed, users in your office network can access this as a central printing device without the need for additional standalone printers.

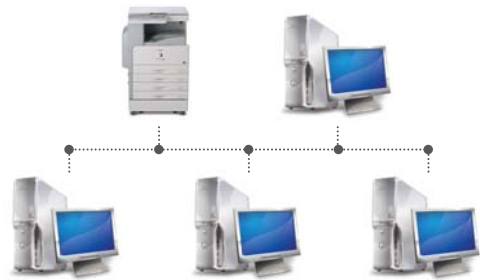

Scan Solution with Color Network ScanGear

The imageRUNNER 2420L/2422L is a black and white multifunctional printer with full color scanning capabilities. Its optional color network scanning supports up to A3 size to provide greater accuracy and electronic document distribution.

The scanned images, imported in black-and-white or full color, can be edited with any Windows TWAIN-compliant applications to create clear, detailed images.



Extend your imageRUNNER's capabilities with optional accessories



imageRUNNER 2420L/2422L

- ▶ 20/22 pages per minute output
- ▶ Standard Local Print, with easy and direct connection through USB
- ▶ Advanced copying features such as Reserved Copy, Frame Erase, Image Combination, Zoom Mode and ID Card Copy
- ▶ Large 5-Line user interface for easy navigation
- ▶ Print outputs collated to your preference for easy and fast distribution

{ OPTIONAL ACCESSORIES }

Auto Duplexing Feeder



DADF-P2

2-Way Paper Output



Inner 2-Way Tray-E2

Network Option



NW IF Adaptor IN-E14

{ ADDITIONAL PAPER CASSETTES }

Paper Cassettes



Cassette Feeding Module-S1



Cassette Feeding Module-T1

{ FINISHER OPTIONS }

Output Option



Finisher-U2

Other Accessories

- Size Adjustor-A1
- iR Pedestal Type G
- iR Pedestal Type H
- Document Tray-J1
- Platen Cover Type J
- Reader Heater Unit-D1
- Cassette Heater Unit-30
- Cassette Heater Kit-D1
- Additional Finisher Tray-C1
- Power Supply-Q1
- Duplex Unit-A1

Supplies and Consumables

- NPG-28 Toner Black
- NPG-28 Drum Black
- Staple Cartridge-J1



NPG-28 Toner

{ SPECIFICATIONS imageRUNNER 2420L/2422L }

Main Unit		
Type	Desktop	
Maximum Original Size	A3	
Developing System	Single component dry toner projection development system	
Fixing System	On-demand Fusing	
Resolution	Reading	600 x 600 dpi
	Printing	600 x 600 dpi
Number of Tones	256	
Acceptable Paper Stock	Paper Drawer	64 to 90 gsm
	Stack Bypass Tray	64 to 128 gsm
Acceptable Paper Size	Paper Drawer	A4, A4R, A3, A5, B4, B5, B5R
	Stack Bypass Tray	95 mm x 148 mm to 297 mm x 432 mm
Warm-Up Time	13 seconds or less	
First Copy Time	7.9 seconds or less (Using platen glass; A4, direct, paper drawer 1)	
Copy Speed (A4)	imageRUNNER 2420L	20 ppm
	imageRUNNER 2422L	22 ppm
Magnification	25 - 400% in 1% increments	
Paper Feeding System	Paper Drawer	250 sheets (80 gsm)
	Stack Bypass Tray	80 sheets (80 gsm)
Output Orientation	Face down	
Multiple Copies	1 to 99 sheets	
Memory	Standard 64 MB	
OS Compatibility	Windows XP Professional/Home Edition, Windows 2000, Windows Server 2003, Windows Vista, Windows Server 2008, Windows 7	
Power Source	220 - 240 V AC, 50/60 Hz, 2.7 A	
Max Power Consumption	Approx. 1.373 kW	
Dimensions (W x D x H)	622 mm x 638 mm x 580.4 mm (one drawer with a platen cover attached)	
	622 mm x 676 mm x 672 mm (one drawer with a feeder attached)	
Weight	Approx. 37.9 kg (one drawer with a platen cover attached)	
	Approx. 43.9 kg (one drawer with a feeder attached)	
Toner Yield	Approx. 8,300 sheets equivalent (A4, 6% coverage)	
Drum Yield	55,000 sheets	
Optional Accessories		
Feeder (DADF-P2)		
Type	Automatic Document Feeder	
Originals	A4, A4R, A3, A5, B4, B5, B5R	
Original Paper Weights	52 gsm to 105 gsm	
Original Tray Capacity	50 sheets (80 gsm)	
Cassette Feeding Module-S1		
Paper Sizes	A4, A4R, A3, A5, B4, B5, B5R	
Paper Capacity	250 sheets x 1 drawer (80 gsm)	
Cassette Feeding Module-T1 *		
Paper Sizes	A4, A4R, A3, A5, B4, B5, B5R	
Paper Capacity	250 sheets x 2 drawers (80 gsm)	
Finisher-U2 *		
Paper	64 gsm to 128 gsm	
Stacking Capacity	770 sheets	
Max Stapling Capacity	50 sheets (Corner Staple only)	
Paper Sizes	A4, A4R, A3, B4, B5	
Duplex Unit-A1		
Paper Sizes	A4, A4R, A3, A5R, B4, B5, B5R	
Paper Weight	64 gsm to 90 gsm	
Inner 2 Way Tray-E2		
Capacity	Tray A	A4/B5: 100 sheets (80 gsm) Other Sizes: 50 sheets (80 gsm)
	Tray B	A4: 250 sheets (80 gsm) Other Sizes: 100 sheets (80 gsm)

* Power Supply-Q1 is required.



Delighting You Always

SOUTH & SOUTHEAST ASIA REGIONAL HEADQUARTERS

Canon Singapore Pte. Ltd.
1 HarbourFront Avenue #04-01, Keppel Bay Tower, Singapore 098632
Tel: +65-6799 8888 | Fax: +65-6799 8882

www.canon-asia.com
www.canon.com.sg

CANON SALES SUBSIDIARIES & BUSINESS PARTNERS

Afghanistan:

Megaplus Afghanistan Limited
House No. 233, Street No. 4,
Charagh Ali, Qilla-e-Fatehullah,
Kabul, Afghanistan
Tel: 93-700 228 832 /
93-700 979 511
Fax: 93-202 201 259
Email: info@megaplus.com.af

Bangladesh:

Flora Limited
Adamjee Court Annex-2 (4th Floor)
119-120 Motijheel Commercial Area
Dhaka 1000 Bangladesh
Tel: 880-2-716-2742-46 / 225
Fax: 880-2-955-0030
www.floralimited.com

Brunei:

Interhouse Company
No. 5-7 Bunut Jaya Complex
Spj 574 Jalan Tutong BF1320
P.O. Box 423, Seri Complex
Bandar Seri Begawan BA 1779
Brunei Darussalam
Tel: 673-2-653-001
Fax: 673-2-653-003

Cambodia:

Royal Cambodia Co., Ltd
#437 Preah Monivong Blvd
Phnom Penh
Kingdom of Cambodia
Tel: 855-23-428955
Fax: 855-23-722961

Hong Kong:

Canon Hongkong Co. Ltd
19F, The Metropolis Tower
10 Metropolis Drive
Hung Hom, Hong Kong
Tel: 852-3191-2388
Fax: 852-2369-3800
www.canon.com.hk

India:

Canon India Private Limited
7th Floor, Tower B, Building #5
DLF Cyber Terraces, DLF Phase-3
Gurgaon - 122002
Haryana, India
Tel: 91-124-416 0000
Fax: 91-124-416 0011
www.canon.co.in

Indonesia:

PT Samafitro
Jalan Ir. H Juanda No.8
Jakarta 10120, Indonesia
Tel: 62-21-345 8989
Fax: 62-21-345 6699
www.samafitro.co.id

Malaysia:

Canon Marketing (Malaysia) Sdn Bhd
Block D, Peremba Square
Saujana Resort Section U2,
40150 Shah Alam
Selangor Darul Ehsan, Malaysia
Tel: 60-3-7844 6000 / 7845 0055
Fax: 60-3-7844 6196 / 6198
www.canon.com.my

Maldives:

Simdi Company Pvt Ltd.
G.Manaam Building,
2/1 Neelofaru Magu,
Male' 20-129, Maldives
Tel: 960-333 4421
Fax: 960-333 4424

Myanmar:

Myanmar Golden Rock International Co., Ltd
Level 6, FJV Commercial Centre
No: 422-426, Strand Road
Botataung Township
Yangon, Myanmar
Tel: 95-1-202092 to 96
Fax: 95-1-202079
Email: sales@mgr.com.mm

Nepal:

International Electronics Concern (P) Ltd
Kha 14, 1st Floor
Haratibhawan Putalisadak
Ramshah Path, Kathmandu, Nepal
P.O. Box 12588
Tel: 977-1-442 1991
Fax: 977-1-442 1909

Pakistan:

Shirazi Trading Company (Pvt.) Ltd
8th Floor, Adamjee House
I.I. Chundrigar Road
Karachi 74000 Pakistan
Tel: 92-21-3241 (7659), (7737) or (7746)
Fax: 92-21-(3241 7747), (3242 0417) or
(3242 0418)
www.shirazitradng.com.pk

Philippines:

Canon Marketing (Philippines), Inc.
Ground Floor Commerce and Industry Plaza.
Campus Ave. Cor. Park Ave., McKinley Hill
Fort Bonifacio, Taguig City
Tel: 632-884-9000
Fax: 632-556-1456
www.canon.com.ph

Sri Lanka:

Metropolitan Office (Pvt) Ltd
12, Magazine Road Colombo 08
Sri Lanka
Tel: 94-11-470 0200
Fax: 94-11-470 0267

Thailand:

Canon Marketing (Thailand) Co. Ltd
10th Floor Bangkok City Tower
179/34-45 South Sathorn Road
Bangkok 10120
Tel: 66-2-344 9999
Fax: 66-2-344 9960
www.canon.co.th

Vietnam:

Canon Singapore Pte Ltd
Ho Chi Minh City Representative Office
Floor 6, Saigon Centre Building
65 Le Loi, Ben Nghe Ward, District 1
Ho Chi Minh City, Vietnam
Tel: 848-3820 0466
Fax: 848-3820 0477

Canon Singapore Pte Ltd
Hanoi Representative Office
CharmVit Building, 11th Floor
117 Tran Duy Hung, Cau Giay District
Hanoi, Vietnam
Tel: 844-3771 1677
Fax: 844-3771 1678
www.canon.com.vn